



Rally “Pagos del Tuyu”

General Juan Madariaga

7ª FECHA (Reprogramada)
CAMPEONATO MAR Y SIERRAS 2012

13 y 14 de Octubre de 2012

Auspicia:

Municipalidad de General Juan Madariaga
Dirección de Deportes – Dirección de Cultura y Turismo

Asociación Madariaguense de Automovilismo
Personería Jurídica N° 1668 Decreto 10-10-80
Martínez Ituño 155 (7163) Gral. Juan Madariaga (Bs As)

www.rallymarsieras.net
cronos_cronometraje@hotmail.com

ANEXOS

CAPITULO 1: PROGRAMA GENERAL DE LA PRUEBA

Artículo 1: CRONOLOGIA

JUEVES 11 de Octubre de 2012:

20:00 Hs.

Cierre del Registro de Inscripciones

VIERNES 12 de Octubre de 2012:

18:00 a 21:00 Hs.

Verificación Administrativa (OPCIONAL)

Se realizara un Parque de Presentacion con los autos presentes para ayudar a la difusión de la carrera

SABADO 16 de ABRIL de 2011:

8:00 Hs.

Verificación Administrativa y Técnica OBLIGATORIA
En Parque de Asistencia

11:00 Hs

Reunión de Pilotos

11:30 hs

Salida 1º Auto de Parque de Asistencia

DOMINGO 17 de ABRIL de 2011:

08:00 Hs.

Salida 1º auto de Parque Cerrado

16.30 Hs.

PODIO – Entrega de Premios

17:00 Hs.

Verificación Técnica Final

Artículo 2: DIRECCIONES OFICIALES

Secretaría Previa del Rally: A.M.A. Martínez Ituño 155.-

Secretaría y Centro de Cómputos: Parque de Asistencia.-

Indicador Oficial de las Clasificaciones: Idem anterior.-

Oficina de Prensa: Idem anterior.-

Verificación Administrativa/Técnica Previa (OPCIONAL): Bar “El Cafetazo” Avellaneda y Sarmiento

Verificación Administrativa/Técnica Previa: Parque de asistencia

Parque de Asistencia: Circuito “El Rebelde”

Parque de Presentación Previa: Sarmiento y Avellaneda

Reunión Previa de Pilotos: Parque de Asistencia

Parque Cerrado entre Etapas: Centro Tradicionalista “Gauchos de Madariaga”.-

Parque Cerrado Final: Sector Parque de Asistencia.-

Podio: Parque de Asistencia.-

Verificación Técnica Final: A.M.A. Martínez Ituño 155.-



ANEXO 1

1. Se utilizaran las siguientes pruebas especiales del Libro de Ruta original de la carrera : Tres Caminos-6 de Octubre, Zorzales-La larga, El Cocal-Circuito El Rebelde. Las cuales se repetiran en dos oportunidades el sabado y tres el domingo.
2. Se emplaza el Parque de Asistencia en el Autodromo El Rebelde
3. Se realizara un Parque de Presentacion no obligatorio para el viernes a la noche, en lugar a definir, esto con motivo de generar difusion local por el hecho de dar por cumplida la Rampa de Largada Simbolica.
4. Se ingresara al circuito El Rebelde por nuevo acceso finalizando en el, la PE El Cocal-Centro Tradicionalista. Ver Anexo 2

HORARIOS ETAPA 1

| CH PE | DESTINO | DISTANCIAS | | | TIEMPO IDEAL | Paso 1º auto |
|-----------------------------------|---------------------------------|--------------|--------|--------|-----------------|-----------------|
| | | PE | ENLACE | SECTOR | | |
| CH 0 | Salida Asistencia | | | | | 11:30 |
| CH 1 | 3 Caminos | | 20,88 | 20,88 | 00:25 | 11:55 |
| PE 1 | 3 Caminos-6 de Octubre | 20,00 | | | | 11:58 |
| CH 2 | El Cocal | | 20,67 | 40,67 | 00:50 | 12:48 |
| PE 2 | El Cocal-El Rebelde | 9,70 | | | | 12:51 |
| CH 2a | Entrada Asistencia-Flexi | | 0,30 | 10,00 | 00:10 | 13:01 |
| FLEXI SERVICE - MAXIMO 15 MINUTOS | | | | | | |
| PARQUE DE ASISTENCIA (A) | | | | | 00:30 | |
| CH 2b | Salida Asistencia-Entrada Reag. | | | | | 13:31 |
| CH 2c | Salida Reagrupamiento | | | Máximo | 00:40 | 14:11 |
| CH 3 | 3 Caminos | | 20,88 | 20,88 | 00:25 | 14:36 |
| PE 3 | 3 Caminos-6 de Octu II | 20,00 | | | | 14:39 |
| CH 4 | El Cocal | | 20,67 | 40,67 | 00:50 | 14:29 |
| PE 4 | El Cocal-El Rebelde II | 9,70 | | | | 15:32 |
| CH 4a | Entrada Asistencia-Flexi | | 0,30 | 10,00 | 00:10 | 15:42 |
| FLEXI SERVICE - MAXIMO 15 MINUTOS | | | | | | |
| PARQUE DE ASISTENCIA (B) | | | | | 00:45 | |
| CH 4b | Salida Asistencia | | | | | 16:27 |
| CH 4c | Entrada Parque Cerrado | | 2,29 | 2,29 | 00:10 | 16:37 |

CH 6b NO PENALIZA ADELANTO





| | | | |
|------------------------------|--------------|--------------|---------------|
| Totales de la etapa 1 | 59,40 | 85,99 | 145,39 |
|------------------------------|--------------|--------------|---------------|

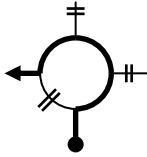
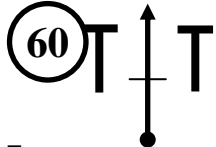
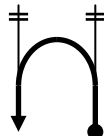
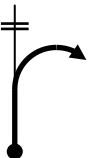
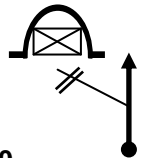
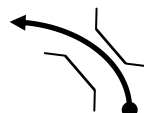

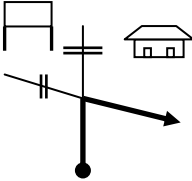
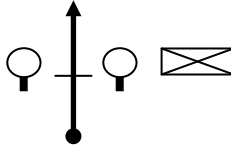

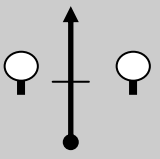
ANEXO 2 A : Enlace Asistencia – PE 1/3

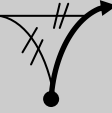



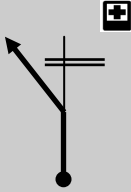

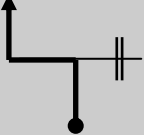
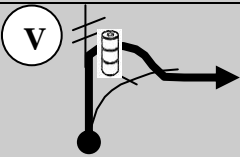
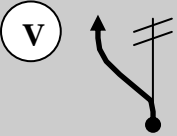

| RALLY PAGOS DEL TUYU 2012 | | DISTANCIA SECTOR 20.88 km | SEC: 1 | HOJA |
|---------------------------|----------------------------|-------------------------------|--|-----------------------|
| CH 0 | Parque de servicios-Salida | PROMEDIO SECTOR 50,11 Km/h | SECTOR 1 | |
| CH 1 | Tres Caminos | | | |
| E | - | DISTANCIA P.E. - | T. IDEAL SECTOR 25' | |
| DISTANCIAS (Km.) | | DIRECCION | REFERENCIAS | DIST. REGRESIVA (Km.) |
| TOTAL | PARCIAL | | | |
| 0.00 | 0.00 | 1 | CH 0 Parque de Servicios - Salida | |
| 0.64 | 0.64 | 2 | !! Sale Autodromo "El Rebelde" | |
| 1.25 | 0.61 | 3 | Comienza asfalto Cementerio a la izquierda | |
| 3.32 | 2.07 | 4 | Toma Av Olavarria Panaderia "Alta Morena" Zona de reductores velocidad | |
| 4.42 | 1.10 | 5 | !! Toma ruta 56 | |

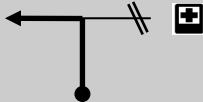



| RALLY PAGOS DEL TUYU 2012 | | DISTANCIA SECTOR 20.88 km | SEC:1 | HOJA |
|---------------------------|--------------------------|--|---|-----------------------|
| CH 0 | Parque Servicio - Salida | PROMEDIO SECTOR | SECTOR | |
| CH 1 | Tres Caminos | 50,11 km/h | 1 | |
| E | - | DISTANCIA P.E. - | T. IDEAL SECTOR 25' | |
| DISTANCIAS (Km.) | | DIRECCION | REFERENCIAS | DIST. REGRESIVA (Km.) |
| TOTAL | PARCIAL | | | |
| 5.84 | 1.42 | 6  | Toma Autovia 74 A Pinamar | |
| 7.48 | 1.64 | 7  | Radar Fotografico MAX 60 Km | |
| 9.14 | 1.66 | 8  | Rotonda La Salada Retoma hacia Madariaga | |
| 9.17 | 0.03 | 9  | Deja Autovia 74 !! Vehiculos de competicion de frente | |
| 10.46 | 1.29 | 10  | Est. "La Providencia" | |
| 14.68 | 4.22 | 11  | ii Puente en curva | |

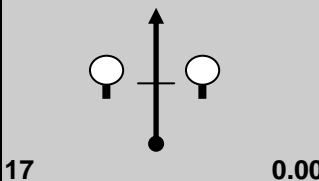

| RALLY PAGOS DEL TUYU 2012 | | DISTANCIA SECTOR 20.88 km | SEC:1 | HOJA |
|---------------------------|--|--|--|-----------------------------|
| CH 0 CH 1 | Parque Servicio - Salida Tres Caminos | PROMEDIO SECTOR 50,11 km/h | SECTOR 1 | |
| E | - | DISTANCIA P.E. - | T. IDEAL SECTOR 25' | |
| DISTANCIAS (Km.) | | DIRECCION | REFERENCIAS | DIST. REGRESIVA (Km.) |
| TOTAL | PARCIAL | | | |
| 20.78 | 6.10 | 12  | | |
| 20.88 | 0.10 | 13  | CH Tres Caminos GPS 37.005597 56.981713 | |

| | | | | |
|---|--------------------------------------|---|--|-----------------------------|
| RALLY PAGOS DEL TUYU 2012 | | DISTANCIA SECTOR 40.67 km | SEC:1 | HOJA |
| LPE 1 CH | Tres Caminos El Cocal | PROMEDIO SECTOR 48.80 km/h | SECTOR 2 | |
| PE 1/3 | Tres Caminos 6 de Octubre | DISTANCIA P.E. 20.00 km | T. IDEAL SECTOR 50' | |
| DISTANCIAS (Km.) | | DIRECCION | REFERENCIAS | DIST. REGRESIVA (Km.) |
| TOTAL | PARCIAL | | | |
| CIRCULAR CON MUCHA PRECAUCION EN LOS DIAS PREVIOS ESTOS CAMINOS TIENEN MUCHO TRAFICO VECINAL | | | | |
| 0.00 | 0.00 |  1 20.00 |  LPE | |
| 2.60 | 2.60 |  2 17.40 | | |
| 3.30 | 0.70 |  3 16.70 | Chicana/Desvio Zona Veedores | |
| 4.19 | 0.89 |  4 15.81 | Chicana/Desvio Zona Veedores | |

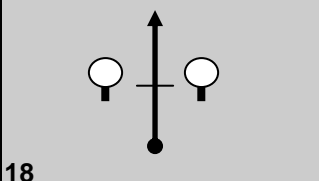

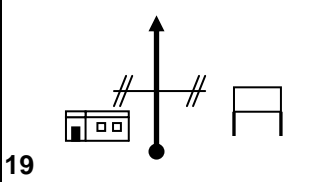
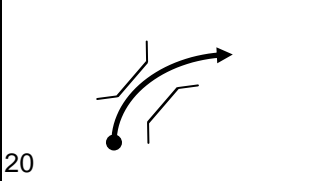
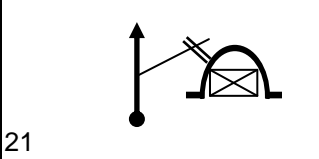
| RALLY PAGOS DEL TUYU 2012 | | DISTANCIA SECTOR 40.67 km | SEC:1 | HOJA |
|---------------------------|--------------------------|--|---|-------------------------------|
| LPE 1 CH | Tres Caminos El Cocal | PROMEDIO SECTOR 48.80 km/h | SECTOR 2 | |
| PE 1/3 | | Tres caminos 6 de Octubre | DISTANCIA P.E. 20.00 km | T. IDEAL SECTOR 50' |
| DISTANCIAS (Km.) | | DIRECCION | REFERENCIAS | DIST. REGRESIVA (Km.) |
| TOTAL | PARCIAL | | | |
| 4.85 | 0.66 |  5 15.15 |  Salida Emergencia n° 7 Hospital Madariaga 22 Km | |
| 7.30 | 2.45 |  6 12.70 | | |
| 8.31 | 1.01 |  7 11.69 | | |
| 9.41 | 1.10 |  8 10.59 | Pasa detrás de gomas Zona de veedores | |
| 10.16 | 0.75 |  9 9.84 | Desvio/Chicana Zona Veedores | |
| 10.36 | 0.20 |  10 9.64 | | |

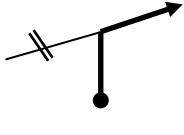
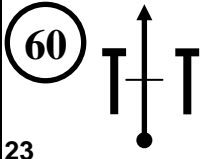
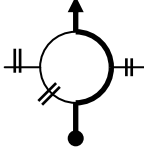
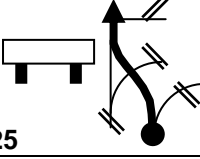

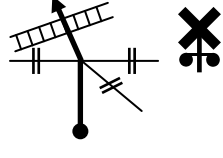

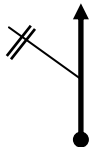
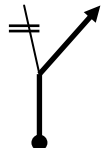
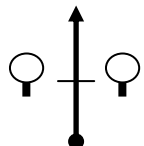
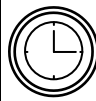
| RALLY PAGOS DEL TUYU 2012 | | DISTANCIA SECTOR 40.67 km | SEC: 1 | HOJA |
|---------------------------|--------------------------|--|---|------------------------|
| LPE 1 CH | Tres Caminos El Cocal | PROMEDIO SECTOR 48.80 km/h | SECTOR 2 | |
| PE 1/3 | | Tres Caminos 6 de Octubre | DISTANCIA P.E. 20.00 km | T. IDEAL SECTOR 50' |
| DISTANCIAS (Km.) | | DIRECCION | REFERENCIAS | DIST. REGRESIVA (Km.) |
| TOTAL | PARCIAL | | | |
| 14.10 | 3.74 |  11 5.90 |  Salida Emergencia n° 8 Hospital Pinamar 20 Km | |
| 15.15 | 1.05 |  12 4.85 | Chicana/Desvio Zona Veedores | |
| 15.80 | 0.65 |  13 4.20 | Chicana/Desvio Zona Veedores | |
| 16.45 | 0.65 |  14 3.55 |  Puente en curva | |
| 18.65 | 2.20 |  15 1.35 | Chicana/Desvio Zona Veedores | |
| 19.40 | 0.75 |  16 0.60 | Chicana/Desvio Zona Veedores | |

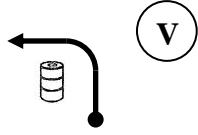
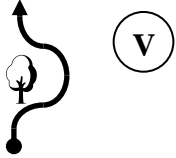
| RALLY PAGOS DEL TUYU 2012 | | DISTANCIA SECTOR 40.67 km | SEC: 1 | HOJA |
|---------------------------|--------------------------|---|--|-------------------------------|
| LPE 1 CH | Tres Caminos El Cocal | PROMEDIO SECTOR 48.80 km/h | SECTOR 2 | |
| PE 1/3 | | Tres Caminos 6 de Octubre | DISTANCIA P.E. 20.00 km | T. IDEAL SECTOR 50' |
| DISTANCIAS (Km.) | | DIRECCION | REFERENCIAS | DIST. REGRESIVA (Km.) |
| TOTAL | PARCIAL | | | |
| 20.00 | 0.60 |  |  FPE | |
| 20.60 | 0.40 |  |  STOP GPS 37.005253 56.981266 | |
| 20.70 | 0.10 |  | !! Precaucion Vehiculos de competición de frente | |
| 26.80 | 6.10 |  | ii Puente en curva | |
| 31.02 | 4.22 |  | Est. "La Providencia" | |

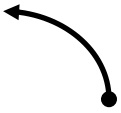
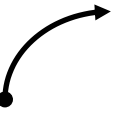
| RALLY PAGOS DEL TUYU 2012 | | DISTANCIA SECTOR 40.67 km | SEC: 1 | HOJA |
|---------------------------|--------------------------|---|--|-----------------------------------|
| LPE 1 CH | Tres Caminos El Cocal | PROMEDIO SECTOR 48.80 km/h | SECTOR 2 | |
| PE 1/3 | | Tres Caminos 6 de Octubre | | DISTANCIA P.E. 20,00 km |
| DISTANCIAS (Km.) | | DIRECCION | | REFERENCIAS |
| TOTAL | PARCIAL | | | DIST. REGRESIVA (Km.) |
| 32.20 | 1.18 |  | ii Toma Autovia 74 A Madariaga | |
| 33.81 | 1.61 |  | Radar Fotografico Max 60 Km | |
| 35.29 | 1.48 |  | Toma Acc a Madariaga | |
| 36.42 | 1.13 |  |  | |
| 36.72 | 0.30 |  | Cruce Ferroviario | |

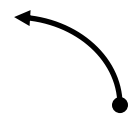
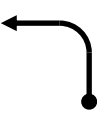
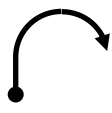
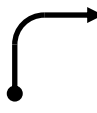
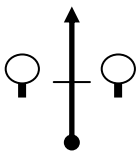
| RALLY PAGOS DEL TUYU 2012 | | DISTANCIA SECTOR 40.67 km | SEC:1 | HOJA |
|---------------------------|--------------------------------------|--|--|-----------------------------|
| LPE 1 CH | Tres Caminos El Cocal | PROMEDIO SECTOR 48.80 km/h | SECTOR 2 | |
| PE 1/3 | Tres Caminos 6 de Octubre | DISTANCIA P.E. 20.00 Km. | T. IDEAL SECTOR 50' | |
| DISTANCIAS (Km.) | | DIRECCION | REFERENCIAS | DIST. REGRESIVA (Km.) |
| TOTAL | PARCIAL | | | |
| 37.57 | 0.85 | 27  | | |
| 38.30 | 0.73 | 28  | | |
| 40.67 | 2.37 | 29  |  CH El Cocal GPS S 36.999171 W 57.159495 | |

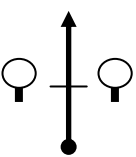
| RALLY DE MADARIAGA 2012 | | DISTANCIA SECTOR | DIA | HOJA |
|------------------------------|--------------------------------|---|--|-----------------------|
| LPE 2 | El Cocal | PROMEDIO SECTOR | SECTOR | |
| CH | Entrada Parque de Asistencia | - | - | |
| PE 2 | El Cocal EL REBELDE | DISTANCIA P.E. | T. IDEAL SECTOR | |
| | | - | - | |
| DISTANCIAS (Km.) | | DIRECCION | REFERENCIAS | DIST. REGRESIVA (Km.) |
| TOTAL | PARCIAL | | | |
| 7.95 | 0.05 |  12 | Pasa por detrás de gomas Sube al circuito Zona de veedores | 2.05 |
| CONTINUA POR CIRCUITO | | | | |
| 8.25 | 0.30 |  13 | Pasa por detrás de planta y sube al circuito | 1.75 |
| 8.35 | 0.10 |  14 | | 1.65 |
| 8.45 | 0.10 |  15 | | 1.55 |
| 8.50 | 0.05 |  16 | | 1.50 |

| RALLY DE MADARIAGA 2012 | | DISTANCIA SECTOR | DIA | HOJA | |
|-------------------------|------------------------------|---|--|-----------------------|-----------------|
| LPE 2 | EL Cocal | PROMEDIO SECTOR | SECTOR | | |
| CH | Entrada Parque de Asistencia | - | - | | |
| PE 2 | | El Cocal EL REBELDE | | DISTANCIA P.E. | T. IDEAL SECTOR |
| DISTANCIAS (Km.) | | DIRECCION | REFERENCIAS | DIST. REGRESIVA (Km.) | |
| TOTAL | PARCIAL | | | | |
| 8.80 | 0.30 |  17 | | 1.20 | |
| 8.90 | 0.10 |  18 | | 1.10 | |
| 9.05 | 0.15 |  19 | | 0.95 | |
| 9.30 | 0.25 |  20 | | 0.70 | |
| 9.70 | 0.40 |  21 |  FPE 2 Frente cabinas s/izquierda | 0.30 | |
| 9.90 | 0.20 |  22 |  STOP | 0.10 | |

| RALLY DE MADARIAGA 2012 | | DISTANCIA SECTOR - | DIA - | HOJA |
|-------------------------|--|---|--|-----------------------------|
| LPE 2 CH | El Cocal Entrada Parque de Asistencia | PROMEDIO SECTOR - | SECTOR - | |
| PE 2 | El Cocal EL REBELDE | DISTANCIA P.E. - | T. IDEAL SECTOR | |
| DISTANCIAS (Km.) | | DIRECCION | REFERENCIAS | DIST. REGRESIVA (Km.) |
| TOTAL | PARCIAL | | | |
| 10.00 | 0.10 |  |  CH 2a Entrada Parque de Asistencia | 0.00 |
| | | 23 | | |

Anexo 2 C – Enlace Asistencia Parque Cerrado

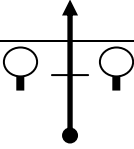
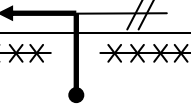
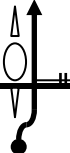
| XXVI RALLY PAGOS DEL TUYU 2012 | | DISTANCIA SECTOR 2.34 km | SEC: | HOJA |
|---|---------|------------------------------------|--|-----------------------|
| CH Asistencia-Salida CH Parque Cerrado - Ingreso | | PROMEDIO SECTOR - | SECTOR | |
| E | - | DISTANCIA P.E. - | T. IDEAL SECTOR 5' | |
| DISTANCIAS (Km.) | | DIRECCION | REFERENCIAS | DIST. REGRESIVA (Km.) |
| TOTAL | PARCIAL | | | |
| 0.00 | 0.00 | 1 | Asistencia - Salida | |
| 0.64 | 0.64 | 2 | !! Sale Autodromo El Rebelde | |
| 1.25 | 0.61 | 3 |  Comienza Asfalto | |
| 1.62 | 0.37 | 4 |  | |
| 1.94 | 0.32 | 5 | Fin Asfalto | |
| 2.20 | 0.26 | 6 |  | |

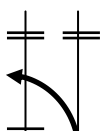



| XXVI RALLY PAGOS DEL TUYU 2012 | | DISTANCIA SECTOR 2.34 km | SEC: | HOJA |
|---|---------|------------------------------------|---|-----------------------------|
| CH Asistencia – Salida CH Parque Cerrado - Ingreso | | PROMEDIO SECTOR - | SECTOR | |
| E | - | DISTANCIA P.E. - | T. IDEAL SECTOR 5' | |
| DISTANCIAS (Km.) | | DIRECCION | REFERENCIAS | DIST. REGRESIVA (Km.) |
| TOTAL | PARCIAL | | | |
| 2.29 | 0.09 | 7 | Ingresa Centro Tradicionalista "Gauchos de Madariaga" | |
| 2.34 | 0.05 | 8 | CH Ingreso Parque Cerrado | |
| <p>Siga Indicaciones</p> <p>-Final Primera Etapa-</p> | | | | |
| | | | | |

HORARIOS ETAPA 2

| CH PE | DESTINO | DISTANCIAS | | | TIEMPO IDEAL | Paso 1º auto |
|-----------------------------------|---------------------------------|--------------|--------|--------|-----------------|-----------------|
| | | PE | ENLACE | SECTOR | | |
| CH 4d | Salida Parque Cerrado | | | | | 08:00 |
| CH 4e | Entrada Asistencia | | 2,29 | 2,29 | 00:10 | 08:10 |
| PARQUE DE ASISTENCIA (C) | | | | | 00:20 | |
| CH 4f | Salida Asistencia | | | | | 08:30 |
| CH 5 | Zorzales | | 9,12 | 9,12 | 00:15 | 08:45 |
| PE 5 | Zorzales-La Larga II | 17,57 | | | | 08:48 |
| CH 6 | El Cocal | | 11,70 | 29,27 | 00:45 | 09:33 |
| PE 6 | El Cocal-El Rebelde II | 9,70 | | | | 09:36 |
| CH 6a | Entrada Asistencia-Flexi | | 0,30 | 10,00 | 00:10 | 09:46 |
| FLEXI SERVICE - MAXIMO 15 MINUTOS | | | | | | |
| PARQUE DE ASISTENCIA (D) | | | | | 00:30 | |
| CH 6b | Salida Asistencia-Entrada Reag. | | | | | 10:16 |
| CH 6c | Salida Reagrupamiento | | | Máximo | 00:50 | 11:06 |
| CH 7 | Zorzales | | 9,12 | 9,12 | 00:15 | 11:21 |
| PE 7 | Zorzales-La Larga III | 17,57 | | | | 11:24 |
| CH 8 | El Cocal | | 11,70 | 29,27 | 00:45 | 12:09 |
| PE 8 | El Cocal-El Rebelde III | 9,70 | | | | 12:12 |
| CH 8a | Entrada Asistencia-Flexi | | 0,30 | 10,00 | 00:10 | 12:22 |
| FLEXI SERVICE - MAXIMO 15 MINUTOS | | | | | | |
| PARQUE DE ASISTENCIA (E) | | | | | 00:30 | |
| CH 8b | Salida Asistencia-Entrada Reag. | | | | | 12:52 |
| CH 8c | Salida Reagrupamiento | | | Máximo | 00:50 | 13:42 |
| CH 9 | Zorzales | | 9,12 | 9,12 | 00:15 | 13:57 |
| PE 9 | Zorzales-La Larga | 17,57 | | | | 14:00 |
| CH 10 | El Cocal | | 11,70 | 29,27 | 00:45 | 14:45 |
| PE 10 | El Cocal-El Rebelde | 9,70 | | | | 14:48 |
| CH10 a | Entrada Asistencia-Flexi | | 0,30 | 10,00 | 00:10 | 14:58 |

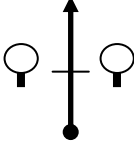
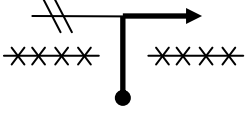
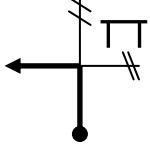

CH 10 a NO PENALIZA ADELANTO

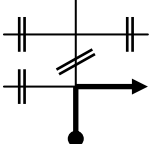
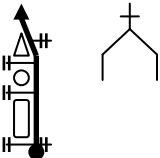

| | | | |
|------------------------------|---------------|---------------|---------------|
| Totales de la etapa 1 | 59,40 | 85,99 | 145,39 |
| Totales de la etapa 2 | 81,81 | 65,65 | 147,46 |
| Totales del Rally | 141,21 | 151,64 | 292,85 |

| XXVI RALLY PAGOS DEL TUYU 2012 | | DISTANCIA SECTOR 2.34 km | SEC: | HOJA |
|---|---------|---|---|------------------------------|
| CH Parque Cerrado-Salida CH Asistencia - Ingreso | | PROMEDIO SECTOR - | SECTOR | |
| E | - | | DISTANCIA P.E. - | T. IDEAL SECTOR 5' |
| DISTANCIAS (Km.) | | DIRECCION | REFERENCIAS | DIST. REGRESIVA (Km.) |
| TOTAL | PARCIAL | | | |
| 0.00 | 0.00 | 1  | CH Parque Cerrado Salida | |
| 0.05 | 0.05 | 2  | Salida Centro Tradicionalista "Gauchos de Madariaga" | |
| 0.14 | 0.09 | 3  | | |
| 0.40 | 0.26 | 4  | Comienza Asfalto | |
| 0.72 | 0.32 | 5  | | |
| 1.09 | 0.37 | 6  | Fin Asfalto | |

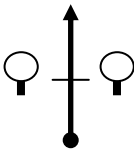
| XXVI RALLY PAGOS DEL TUYU 2012 | | DISTANCIA SECTOR 2.34 km | SEC: | HOJA |
|---|---------|---|----------------------------------|-----------------------------|
| CH Parque Cerrado – Salida CH Asistencia - Ingreso | | PROMEDIO SECTOR - | SECTOR | |
| E | - | DISTANCIA P.E. - | T. IDEAL SECTOR 5' | |
| DISTANCIAS (Km.) | | DIRECCION | REFERENCIAS | DIST. REGRESIVA (Km.) |
| TOTAL | PARCIAL | | | |
| 1.70 | 0.61 | 7  | Ingresa Circuito "El Rebelde" | |
| 2.34 | 0.64 | 8  | CH Ingreso Asistencia | |
| | | | | |

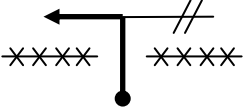
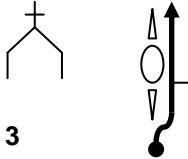
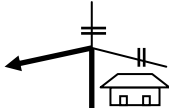
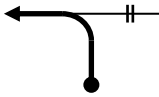
Anexo 2: Enlace Asistencia PE 5/7/9

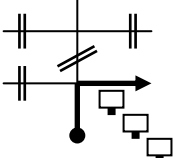
| RALLY PAGOS DEL TUYU 2012 | | DISTANCIA SECTOR 9.12 km | SEC: 3 | HOJA |
|---------------------------|--|---|---|-----------------------------|
| CH CH | Parque de servicios-Salida Zorzales | PROMEDIO SECTOR 39.10 Km/h | SECTOR | |
| E | - | DISTANCIA P.E. - | T. IDEAL SECTOR 15' | |
| DISTANCIAS (Km.) | | DIRECCION | REFERENCIAS | DIST. REGRESIVA (Km.) |
| TOTAL | PARCIAL | | | |
| 0.00 | 0.00 | 1  |  CH 0 Parque de Servicios - Salida | |
| 0.64 | 0.64 | 2  | !! Sale Autodromo "El Rebelde" | |
| 1.25 | 0.61 | 3  | Comienza asfalto Cementerio a la izquierda | |
| 3.32 | 2.07 | 4  | Toma Av Olavarria Panaderia "Alta Morena" Zona de reductores velocidad | |
| 4.42 | 1.10 | 5  | !! Toma ruta 56 | |

| RALLY PAGOS DEL TUYU 2012 | | DISTANCIA SECTOR 9.12 km | SEC: 3 | HOJA |
|---------------------------|--|--|--|-----------------------------|
| CH CH | Parque de servicios-Salida Zorzales | PROMEDIO SECTOR 39.10 Km/h | SECTOR | |
| E | - | DISTANCIA P.E. - | T. IDEAL SECTOR 15' | |
| DISTANCIAS (Km.) | | DIRECCION | REFERENCIAS | DIST. REGRESIVA (Km.) |
| TOTAL | PARCIAL | | | |
| 8.32 | 3.90 | 6  | ! Deja Asfalto Despues de ultimo indicador de curva | |
| 9.12 | 0.80 | 7  |  CH Zorzales GPS 36.58046 57.06493 | |